

SCALE: 1"=60'
 BASIS OF BEARINGS
 STATE PLANE COORDINATE SYSTEM
 NORTH CENTRAL ZONE
 N 53°02'31" E
 BETWEEN CITY OF ROCKWALL MONUMENTS
 R002 & M929 (NAD 83)

- LEGEND**
- 1/2" I.R.F.C. 1/2" IRON ROD FOUND WITH PLASTIC CAP STAMPED "WEIR & ASSOC"
 - 5/8" I.R.S. 5/8" IRON ROD SET WITH PLASTIC CAP STAMPED "R.P.L.S. 5199"
 - C.M.F. CONCRETE MONUMENT FOUND (TXDOT)
 - D.E. DRAINAGE EASEMENT
 - D.R.R.C.T. DEED RECORDS, ROCKWALL COUNTY, TEXAS
 - F.A. & U.E. FIRELANE, ACCESS & UTILITY EASEMENT
 - F.M.S. FLOODPLAIN MONUMENT SET
 - M.F.F.E. MINIMUM FINISHED FLOOR ELEVATION
 - P.O.B. POINT OF BEGINNING
 - R.O.W. RIGHT-OF-WAY
 - S.S.E. SANITARY SEWER EASEMENT
 - W.E. WATER EASEMENT

REMAINDER OF 123.4 ACRES
 THE CAMBRIDGE COMPANIES, INC., TRUSTEE
 (VOLUME 99, PAGE 1022, D.R.R.C.T.)

SEE DETAIL "A"

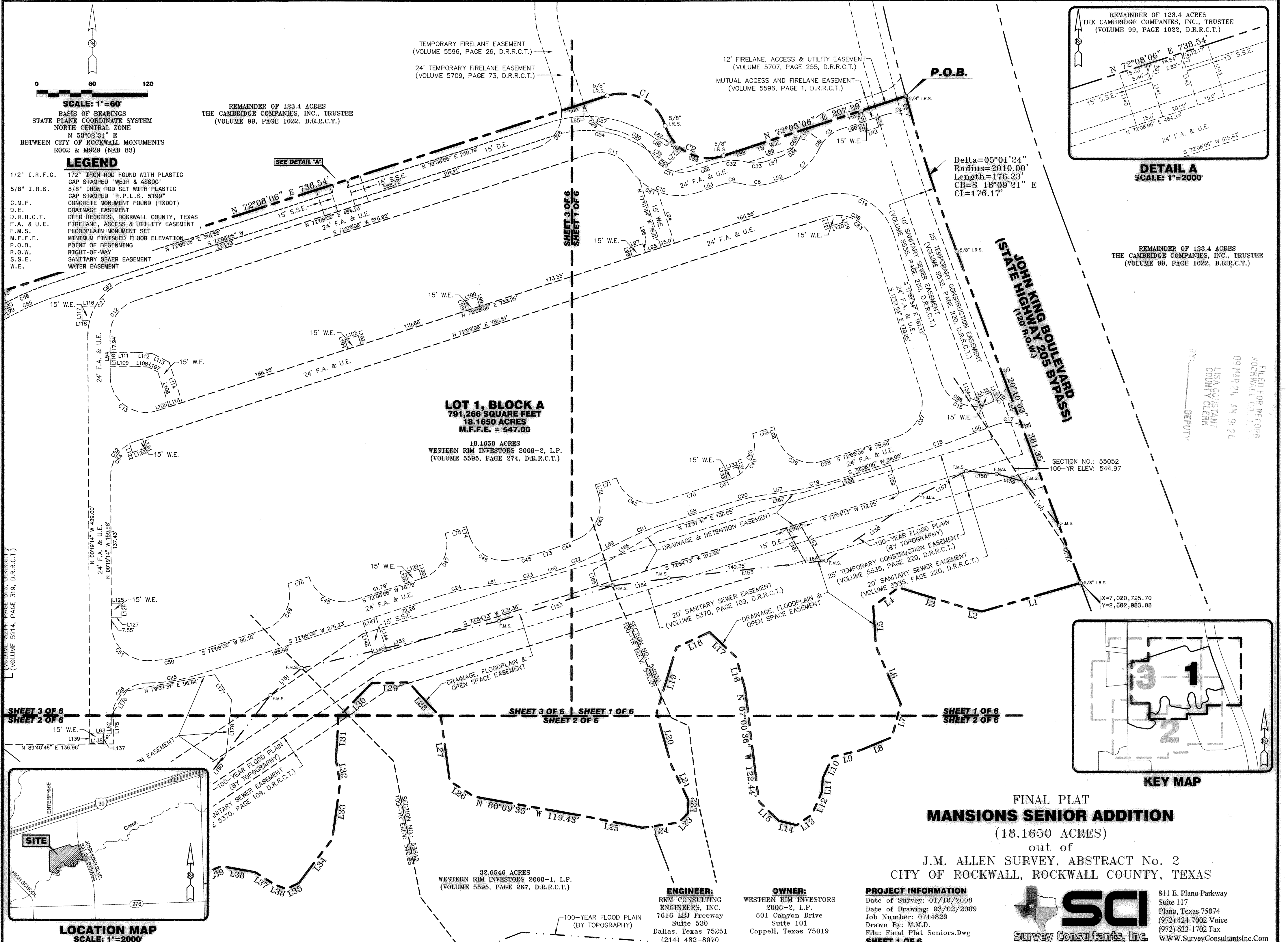

LOT 1, BLOCK A
 791,266 SQUARE FEET
 18.1650 ACRES
 M.F.F.E. = 547.00

18.1650 ACRES
 WESTERN RIM INVESTORS 2008-2, L.P.
 (VOLUME 5595, PAGE 274, D.R.R.C.T.)

32.6546 ACRES
 WESTERN RIM INVESTORS 2008-1, L.P.
 (VOLUME 5595, PAGE 267, D.R.R.C.T.)

ENGINEER:
 RKM CONSULTING
 ENGINEERS, INC.
 7616 LBJ Freeway
 Suite 530
 Dallas, Texas 75251
 (214) 432-8070

OWNER:
 WESTERN RIM INVESTORS
 2008-2, L.P.
 601 Canyon Drive
 Suite 101
 Coppell, Texas 75019

PROJECT INFORMATION
 Date of Survey: 01/10/2008
 Date of Drawing: 03/02/2009
 Job Number: 0714829
 Drawn By: M.M.D.
 File: Final Plat Seniors.Dwg
SHEET 1 OF 6

SCI
 Survey Consultants, Inc.
 811 E. Plano Parkway
 Suite 117
 Plano, Texas 75074
 (972) 424-7002 Voice
 (972) 633-1702 Fax
 WWW.SurveyConsultantsInc.Com

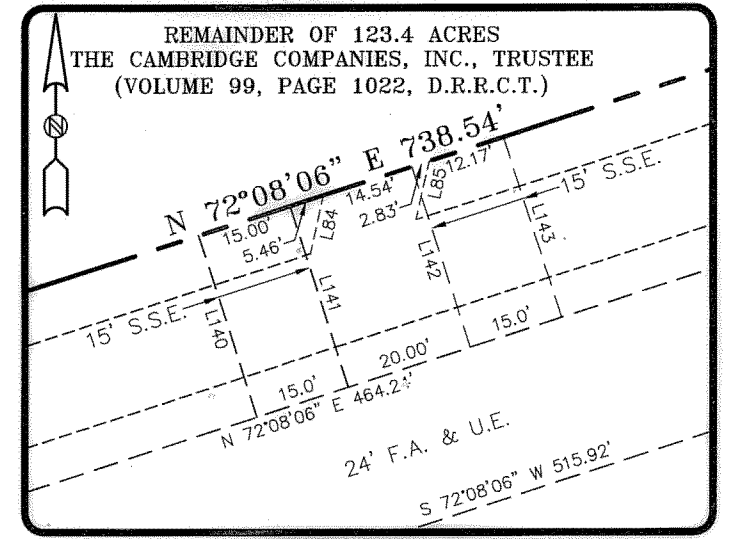

DETAIL A
 SCALE: 1"=2000'

REMAINDER OF 123.4 ACRES
 THE CAMBRIDGE COMPANIES, INC., TRUSTEE
 (VOLUME 99, PAGE 1022, D.R.R.C.T.)

FILED FOR ME CORRE
 ROCKWALL COUNTY CLERK
 LISA CONSTANT
 COUNTY CLERK
 09 MAR 24 AM 9:24
 DEPUTY

SECTION NO.: 55052
 100-YR ELEV.: 544.97

X=7,020,725.70
 Y=2,602,983.08

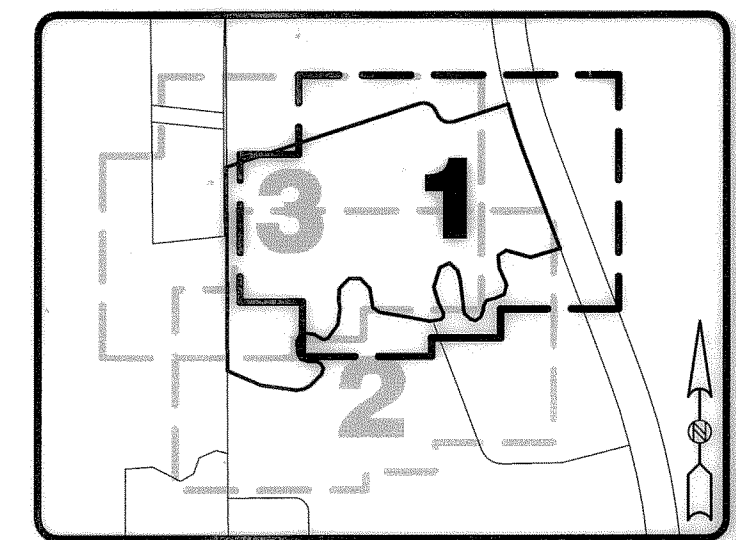

KEY MAP

SHEET 3 OF 6
 SHEET 2 OF 6

SHEET 3 OF 6
 SHEET 1 OF 6
 SHEET 2 OF 6

SHEET 1 OF 6
 SHEET 2 OF 6

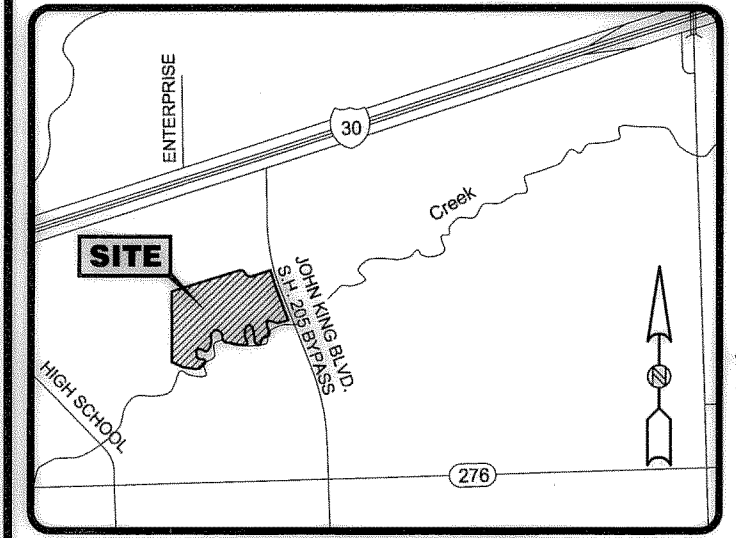

LOCATION MAP
 SCALE: 1"=2000'

FINAL PLAT
MANSIONS SENIOR ADDITION

(18.1650 ACRES)

out of
 J.M. ALLEN SURVEY, ABSTRACT No. 2
 CITY OF ROCKWALL, ROCKWALL COUNTY, TEXAS

0 60 120

SCALE: 1"=60'

BASIS OF BEARINGS
STATE PLANE COORDINATE SYSTEM
NORTH CENTRAL ZONE
N 53°02'31" E
BETWEEN CITY OF ROCKWALL MONUMENTS
R002 & M929 (NAD 83)

LEGEND

- 1/2" I.R.F.C. 1/2" IRON ROD FOUND WITH PLASTIC CAP STAMPED "WEIR & ASSOC"
- 5/8" I.R.S. 5/8" IRON ROD SET WITH PLASTIC CAP STAMPED "R.P.L.S. 5199"
- C.M.F. CONCRETE MONUMENT FOUND (TXDOT)
- D.E. DRAINAGE EASEMENT
- D.R.R.C.T. DEED RECORDS, ROCKWALL COUNTY, TEXAS
- F.A. & U.E. FIRELANE, ACCESS & UTILITY EASEMENT
- F.M.S. FLOODPLAIN MONUMENT SET
- M.F.F.E. MINIMUM FINISHED FLOOR ELEVATION
- P.O.B. POINT OF BEGINNING
- R.O.W. RIGHT-OF-WAY
- S.S.E. SANITARY SEWER EASEMENT
- W.E. WATER EASEMENT

30' DRAINAGE EASEMENT
(VOLUME 5214, PAGE 313, D.R.R.C.T.)
(VOLUME 5214, PAGE 319, D.R.R.C.T.)

SHEET 3 OF 6
SHEET 2 OF 6

SHEET 3 OF 6 | SHEET 1 OF 6
SHEET 2 OF 6

SHEET 1 OF 6
SHEET 2 OF 6

22.303 ACRES
THOMAS REAL ESTATE, L.P.
(VOLUME 1507, PAGE 203, D.R.R.C.T.)

32.6546 ACRES
WESTERN RIM INVESTORS 2008-1, L.P.
(VOLUME 5595, PAGE 287, D.R.R.C.T.)

REMAINDER 123.4 ACRE TRACT
THE CAMBRIDGE COMPANIES, INC., TRUSTEE
(VOLUME 99, PAGE 1022, D.R.R.C.T.)

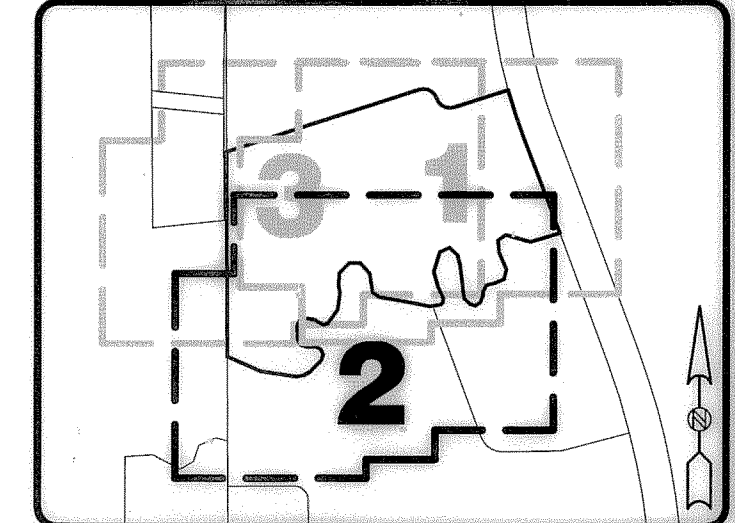
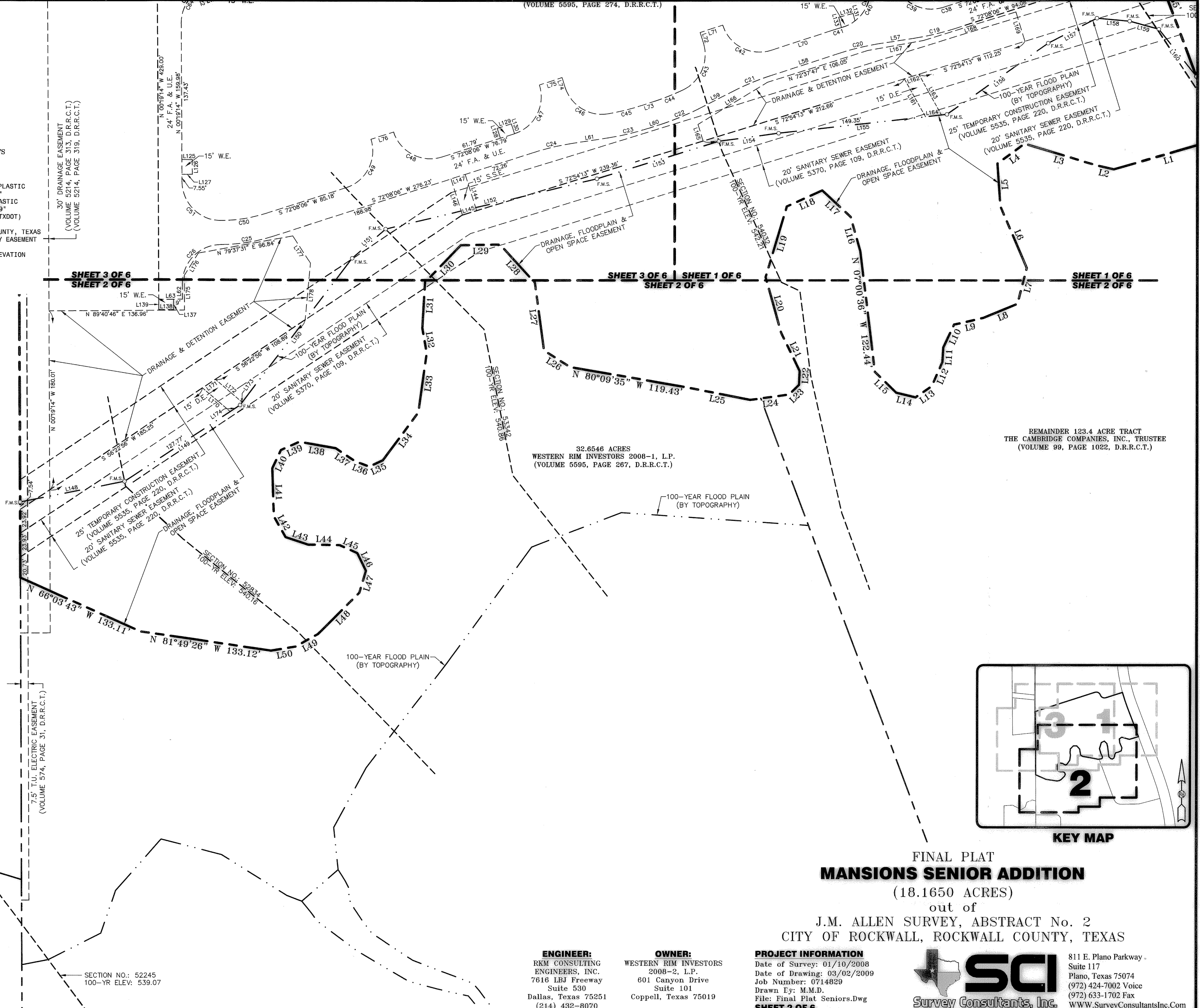

KEY MAP

FINAL PLAT
MANSIONS SENIOR ADDITION
(18.1650 ACRES)

out of
J.M. ALLEN SURVEY, ABSTRACT No. 2
CITY OF ROCKWALL, ROCKWALL COUNTY, TEXAS

ENGINEER:
RKM CONSULTING
ENGINEERS, INC.
7616 LBJ Freeway
Suite 530
Dallas, Texas 75251
(214) 432-8070

OWNER:
WESTERN RIM INVESTORS
2008-2, L.P.
601 Canyon Drive
Suite 101
Coppell, Texas 75019

PROJECT INFORMATION
Date of Survey: 01/10/2008
Date of Drawing: 03/02/2009
Job Number: 0714829
Drawn By: M.M.D.
File: Final Plat Seniors.Dwg
SHEET 2 OF 6

SCI
Survey Consultants, Inc.
811 E. Plano Parkway -
Suite 117
Plano, Texas 75074
(972) 424-7002 Voice
(972) 633-1702 Fax
WWW.SurveyConsultantsInc.Com

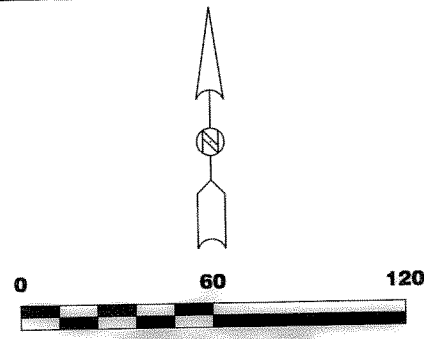

SCALE: 1"=60'
 BASIS OF BEARINGS
 STATE PLANE COORDINATE SYSTEM
 NORTH CENTRAL ZONE
 N 53°02'31" E
 BETWEEN CITY OF ROCKWALL MONUMENTS
 R002 & M929 (NAD 83)

- LEGEND**
- 1/2" I.R.F.C. 1/2" IRON ROD FOUND WITH PLASTIC CAP STAMPED "WEIR & ASSOC"
 - 5/8" I.R.S. 5/8" IRON ROD SET WITH PLASTIC CAP STAMPED "R.P.L.S. 5199"
 - C.M.F. CONCRETE MONUMENT FOUND (TXDOT)
 - D.E. DRAINAGE EASEMENT
 - D.R.R.C.T. DEED RECORDS, ROCKWALL COUNTY, TEXAS
 - F.A. & U.E. FIRELANE, ACCESS & UTILITY EASEMENT
 - F.M.S. FLOODPLAIN MONUMENT SET
 - M.F.F.E. MINIMUM FINISHED FLOOR ELEVATION
 - P.O.B. POINT OF BEGINNING
 - R.O.W. RIGHT-OF-WAY
 - S.S.E. SANITARY SEWER EASEMENT
 - W.E. WATER EASEMENT

60' STREET
 (CABINET F, SLIDE 379, P.R.R.C.T.)

LOT 1, BLOCK 2
 ROCKWALL RECREATIONAL ADDITION
 (CABINET F, SLIDE 379, P.R.R.C.T.)

X=7,021,024.26
 Y=2,601,767.51

7.5" T.U. ELECTRIC EASEMENT
 (VOLUME 574, PAGE 31, D.R.R.C.T.)

30' DRAINAGE EASEMENT
 (VOLUME 5214, PAGE 313, D.R.R.C.T.)
 (VOLUME 5214, PAGE 319, D.R.R.C.T.)

SHEET 3 OF 6
 SHEET 2 OF 6

SHEET 3 OF 6 | SHEET 1 OF 6
 SHEET 2 OF 6

REMAINDER OF 123.4 ACRES
 THE CAMBRIDGE COMPANIES, INC., TRUSTEE
 (VOLUME 99, PAGE 1022, D.R.R.C.T.)

TEMPORARY FIRELANE EASEMENT
 (VOLUME 5596, PAGE 26, D.R.R.C.T.)
 24' TEMPORARY FIRELANE EASEMENT
 (VOLUME 5709, PAGE 73, D.R.R.C.T.)

12' FIRELANE, ACCESS & UTILITY EASEMENT
 (VOLUME 5707, PAGE 25)
 MUTUAL ACCESS AND FIRELANE EASEMENT
 (VOLUME 5596, PAGE 1, D.R.R.C.T.)

LOT 1, BLOCK A
791,266 SQUARE FEET
18.1650 ACRES
M.F.F.E. = 547.00

18.1650 ACRES
 WESTERN RIM INVESTORS 2008-2, L.P.
 (VOLUME 5595, PAGE 274, D.R.R.C.T.)

22.303 ACRES
 THOMAS REAL ESTATE, L.P.
 (VOLUME 1507, PAGE 203, D.R.R.C.T.)

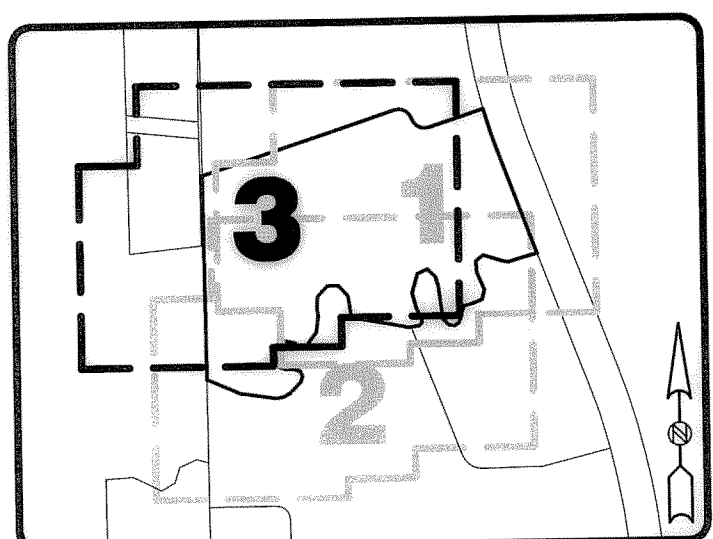

KEY MAP

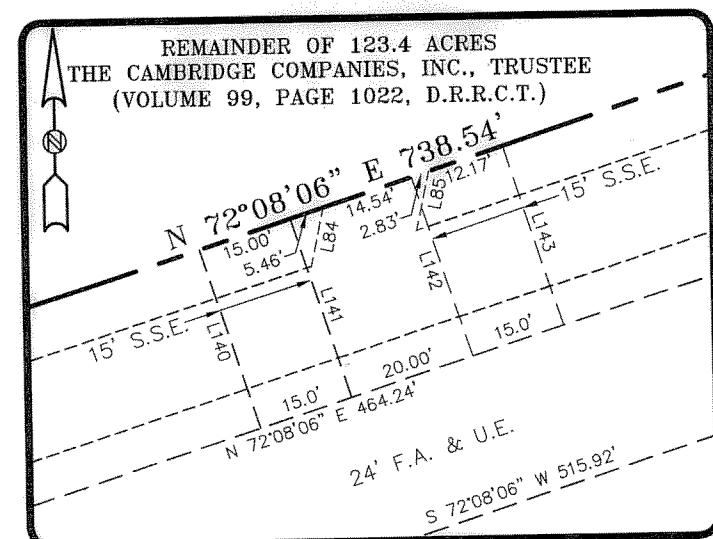

DETAIL A
SCALE: 1"=2000'

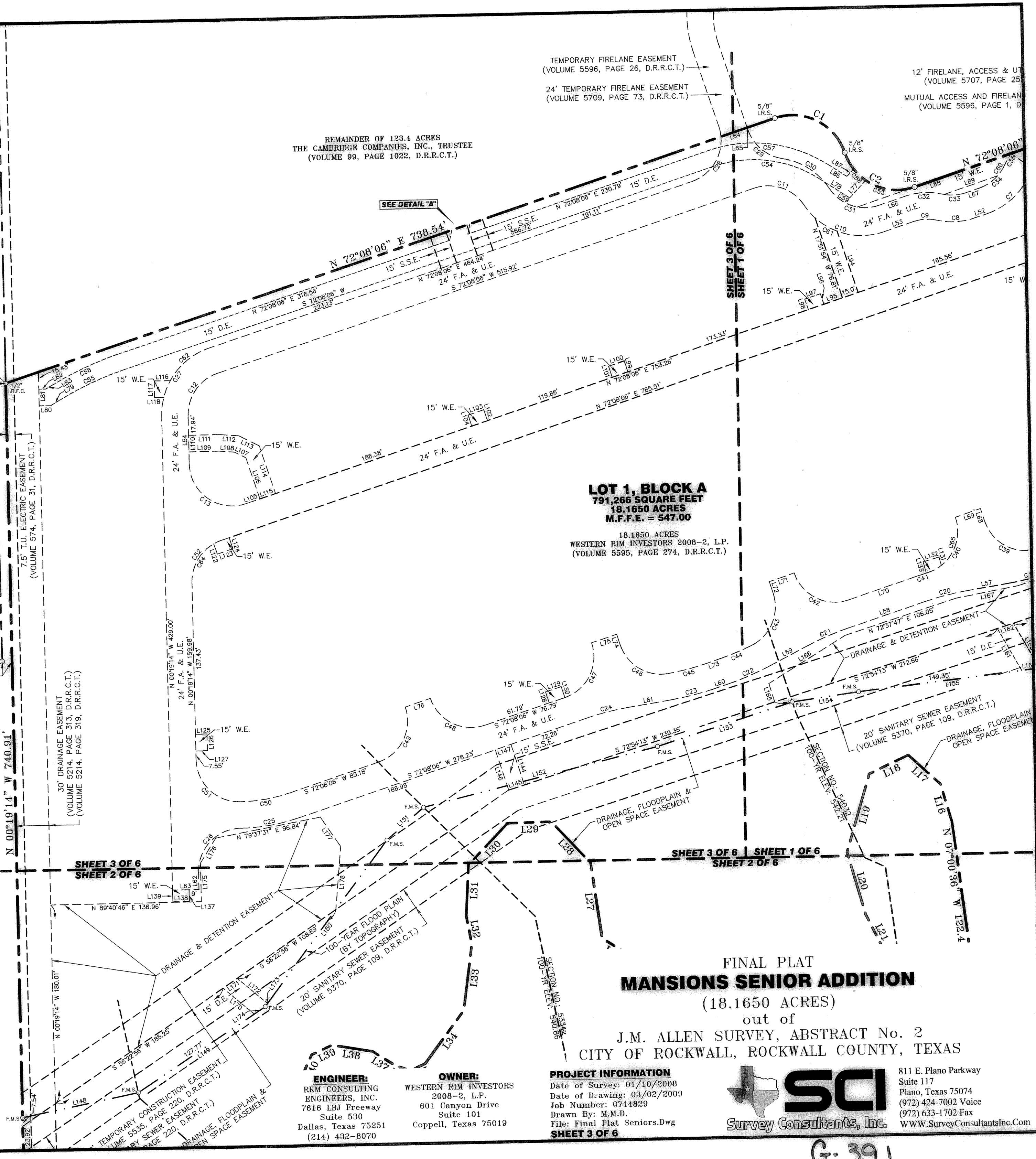

FINAL PLAT
MANSIONS SENIOR ADDITION
 (18.1650 ACRES)

out of
 J.M. ALLEN SURVEY, ABSTRACT No. 2
 CITY OF ROCKWALL, ROCKWALL COUNTY, TEXAS

ENGINEER:
 RKM CONSULTING ENGINEERS, INC.
 7616 LBJ Freeway Suite 530
 Dallas, Texas 75251
 (214) 432-8070

OWNER:
 WESTERN RIM INVESTORS
 2008-2, L.P.
 601 Canyon Drive Suite 101
 Coppell, Texas 75019

PROJECT INFORMATION
 Date of Survey: 01/10/2008
 Date of Drawing: 03/02/2009
 Job Number: 0714829
 Drawn By: M.M.D.
 File: Final Plat Seniors.Dwg
SHEET 3 OF 6

811 E. Plano Parkway
 Suite 117
 Plano, Texas 75074
 (972) 424-7002 Voice
 (972) 633-1702 Fax
 WWW.SurveyConsultantsInc.Com

G-391

LINE TABLE

Table with 3 columns: NUMBER, DIRECTION, DISTANCE. Rows L1 to L82.

LINE TABLE

Table with 3 columns: NUMBER, DIRECTION, DISTANCE. Rows L83 to L164.

LINE TABLE

Table with 3 columns: NUMBER, DIRECTION, DISTANCE. Rows L165 to L178.

CURVE TABLE

Table with 6 columns: NUMBER, DELTA, RADIUS, LENGTH, CHORD BEARING, CHORD. Rows C1 to C33.

CURVE TABLE

Table with 6 columns: NUMBER, DELTA, RADIUS, LENGTH, CHORD BEARING, CHORD. Rows C34 to C66.

**FINAL PLAT
MANSIONS SENIOR ADDITION**

(18.1650 ACRES)

out of

J.M. ALLEN SURVEY, ABSTRACT No. 2
CITY OF ROCKWALL, ROCKWALL COUNTY, TEXAS

ENGINEER:
RKM CONSULTING ENGINEERS, INC.
7616 LBJ Freeway Suite 530
Dallas, Texas 75251
(214) 432-8070

OWNER:
WESTERN RIM INVESTORS
2008-2, L.P.
601 Canyon Drive Suite 101
Coppell, Texas 75019

PROJECT INFORMATION
Date of Survey: 01/10/2008
Date of Drawing: 03/02/2009
Job Number: 0714829
Drawn By: M.M.D.
File: Final Plat Seniors.Dwg
SHEET 4 OF 6

 811 E. Plano Parkway
Suite 117
Plano, Texas 75074
(972) 424-7002 Voice
(972) 633-1702 Fax
WWW.SurveyConsultantsInc.Com

G.392

OWNER'S CERTIFICATE

STATE OF TEXAS §
COUNTY OF ROCKWALL §

WHEREAS Western Rim Investors 2008-2, L.P., is the owner of a tract of land in the City of Rockwall, Rockwall County, Texas out of the J.M. Allen Survey, Abstract No. 2 and being all of a 18.1650 acre tract of land conveyed to Western Rim Investors 2008-2, L.P. according to the deed filed for record in Volume 5595, Page 274, Deed Records, Rockwall County, Texas, and being more particularly described by metes and bounds as follows:

BEGINNING at a 5/8" iron rod set with plastic cap stamped "R.P.L.S. 5199" " in the west right of way line of John King Boulevard (State Highway 205 Bypass) (120' right of way), as recorded in Cabinet G, Slides 265-267, Plat Records, Rockwall County, Texas, the northeast corner of said 18.1650 acre tract, the beginning of a curve to the left;

THENCE, along said west right of way line, the east line of said 18.1650 acre tract, along said curve to the left through a central angle of 05 degrees 01 minutes 24 seconds, a radius of 2010.00 feet, an arc length of 176.23 feet, a chord bearing of South 18 degrees 09 minutes 21 seconds East, a chord distance of 176.17 feet, to a 5/8" iron rod set with plastic cap stamped "R.P.L.S. 5199", the end of said curve;

THENCE, continuing along said common line, South 20 degrees 40 minutes 03 seconds East, a distance of 381.35 feet to a 5/8" iron rod set with plastic cap stamped "R.P.L.S. 5199", the southeast corner of said 18.1650 acre tract;

THENCE, departing said west right of way line, along the south line of said 18.1650 acre tract the following courses:

- THENCE, South 73 degrees 55 minutes 55 seconds West, a distance of 111.26 feet;
- THENCE, North 76 degrees 59 minutes 45 seconds West, a distance of 18.01 feet;
- THENCE, North 73 degrees 16 minutes 18 seconds West, a distance of 75.80 feet;
- THENCE, South 53 degrees 49 minutes 11 seconds West, a distance of 34.08 feet;
- THENCE, South 04 degrees 01 minutes 26 seconds East, a distance of 43.03 feet;
- THENCE, South 23 degrees 28 minutes 50 seconds East, a distance of 67.39 feet;
- THENCE, South 14 degrees 38 minutes 07 seconds West, a distance of 37.25 feet;
- THENCE, South 67 degrees 30 minutes 17 seconds West, a distance of 37.25 feet;
- THENCE, South 76 degrees 55 minutes 37 seconds West, a distance of 30.42 feet;
- THENCE, South 25 degrees 04 minutes 05 seconds West, a distance of 25.43 feet;
- THENCE, South 03 degrees 30 minutes 19 seconds West, a distance of 14.68 feet;
- THENCE, South 23 degrees 58 minutes 21 seconds West, a distance of 26.52 feet;
- THENCE, South 55 degrees 23 minutes 11 seconds West, a distance of 20.02 feet;
- THENCE, North 76 degrees 09 minutes 16 seconds West, a distance of 20.02 feet;
- THENCE, North 46 degrees 09 minutes 54 seconds West, a distance of 29.88 feet;
- THENCE, North 07 degrees 00 minutes 36 seconds West, a distance of 122.44 feet;
- THENCE, North 16 degrees 01 minutes 39 seconds West, a distance of 35.67 feet;
- THENCE, North 47 degrees 04 minutes 13 seconds West, a distance of 39.28 feet;
- THENCE, South 65 degrees 35 minutes 42 seconds West, a distance of 39.28 feet;
- THENCE, South 16 degrees 51 minutes 30 seconds West, a distance of 73.78 feet;
- THENCE, South 15 degrees 43 minutes 54 seconds East, a distance of 58.28 feet;
- THENCE, South 25 degrees 59 minutes 04 seconds East, a distance of 42.88 feet;
- THENCE, South 02 degrees 43 minutes 49 seconds West, a distance of 13.91 feet;
- THENCE, South 45 degrees 37 minutes 24 seconds West, a distance of 13.91 feet;

THENCE, South 82 degrees 07 minutes 14 seconds West, at 28.88 feet passing the northeast corner of a 32.6546 acre tract of land conveyed to Western Rim Investors 2008-1, L.P. according to the deed filed for record in Volume 5595, Page 267, Deed Records, Rockwall County, Texas and continuing along said south line, the north line of said 32.6546 acre tract, a total distance in all of 39.76 feet;

THENCE, continuing along said common line the following courses:

- THENCE, South 82 degrees 07 minutes 14 seconds West, a distance of 10.88 feet;
- THENCE, North 78 degrees 47 minutes 59 seconds West, a distance of 65.58 feet;
- THENCE, North 80 degrees 09 minutes 35 seconds West, a distance of 119.43 feet;
- THENCE, North 57 degrees 42 minutes 43 seconds West, a distance of 31.18 feet;
- THENCE, North 07 degrees 48 minutes 51 seconds West, a distance of 69.08 feet;
- THENCE, North 42 degrees 38 minutes 50 seconds West, a distance of 51.87 feet;
- THENCE, South 89 degrees 02 minutes 20 seconds West, a distance of 39.75 feet;
- THENCE, South 44 degrees 04 minutes 00 seconds West, a distance of 51.84 feet;
- THENCE, South 03 degrees 22 minutes 50 seconds West, a distance of 46.47 feet;
- THENCE, South 10 degrees 14 minutes 56 seconds East, a distance of 25.54 feet;

OWNER'S CERTIFICATE

- THENCE, South 07 degrees 57 minutes 59 seconds West, a distance of 60.06 feet;
- THENCE, South 36 degrees 42 minutes 39 seconds West, a distance of 60.06 feet;
- THENCE, South 65 degrees 14 minutes 17 seconds West, a distance of 15.18 feet;
- THENCE, North 68 degrees 53 minutes 22 seconds West, a distance of 15.18 feet;
- THENCE, North 56 degrees 44 minutes 15 seconds West, a distance of 23.47 feet;
- THENCE, North 80 degrees 04 minutes 42 seconds West, a distance of 37.36 feet;
- THENCE, South 65 degrees 53 minutes 42 seconds West, a distance of 20.38 feet;
- THENCE, South 25 degrees 19 minutes 42 seconds West, a distance of 20.38 feet;
- THENCE, South 01 degrees 48 minutes 48 seconds East, a distance of 48.46 feet;
- THENCE, South 29 degrees 44 minutes 20 seconds East, a distance of 24.17 feet;
- THENCE, South 71 degrees 52 minutes 24 seconds East, a distance of 24.17 feet;
- THENCE, South 89 degrees 26 minutes 38 seconds East, a distance of 31.59 feet;
- THENCE, South 65 degrees 58 minutes 59 seconds East, a distance of 19.73 feet;
- THENCE, South 26 degrees 03 minutes 15 seconds East, a distance of 19.73 feet;
- THENCE, South 16 degrees 39 minutes 57 seconds West, a distance of 22.89 feet;
- THENCE, South 45 degrees 00 minutes 49 seconds West, a distance of 59.09 feet;
- THENCE, South 60 degrees 31 minutes 41 seconds West, a distance of 25.54 feet;
- THENCE, South 80 degrees 22 minutes 22 seconds West, a distance of 25.54 feet;
- THENCE, North 81 degrees 49 minutes 26 seconds West, a distance of 133.12 feet;

THENCE, North 66 degrees 03 minutes 43 seconds West, a distance of 133.11 feet to a point in the east line of a 22.303 acre tract of land conveyed to Thomas Real Estate, L.P. according to the deed filed for record in Volume 1507, Page 203, Deed Records, Rockwall County, Texas, the southwest corner of said 18.1650 acre tract, the northwest corner of said 32.6546 acre tract,

THENCE, along the west line of said 18.1650 acre tract, part way with the east line of said 22.303 acre tract, North 00 degrees 19 minutes 14 seconds West, a distance of 740.91 feet to a 1/2" iron rod found with plastic cap stamped "Weir & Assoc", the northwest corner of said 18.1650 acre tract;

THENCE, along the north line of said 18.1650 acre tract, North 72 degrees 08 minutes 06 seconds East, a distance of 738.54 feet to a 5/8" iron rod set with plastic cap stamped "R.P.L.S. 5199", the beginning of a curve to the right;

THENCE, continuing along said north line, along said curve to the right through a central angle of 90 degrees 00 minutes 00 seconds, a radius of 50.00 feet, an arc length of 78.54 feet, a chord bearing of South 62 degrees 51 minutes 54 seconds East, a chord distance of 70.71 feet to a 5/8" iron rod set with plastic cap stamped "R.P.L.S. 5199", the beginning of a curve to the left;

THENCE, continuing along said north line, along said curve to the left through a central angle of 90 degrees 00 minutes 00 seconds, a radius of 50.00 feet, an arc length of 78.54 feet, a chord bearing of South 62 degrees 51 minutes 54 seconds East, a chord distance of 70.71 feet to a 5/8" iron rod set with plastic cap stamped "R.P.L.S. 5199", the end of said curve;

THENCE, continuing along said north line, North 72 degrees 08 minutes 06 seconds East, a distance of 207.29 feet to the POINT OF BEGINNING and containing 791,266 square feet or 18.1650 acres of land, more or less.

NOW, THEREFORE, KNOW ALL MEN BY THESE PRESENTS:

STATE OF TEXAS §
COUNTY OF ROCKWALL §

I the undersigned owner of the land shown on this plat, and designated herein as the MANSIONS SENIOR ADDITION subdivision to the City of Rockwall, Texas, and whose name is subscribed hereto, hereby dedicate to the use of the public forever all streets, alleys, parks, water courses, drains, easements and public places thereon shown on the purpose and consideration therein expressed. I further certify that all other parties who have a mortgage or lien interest in the MANSIONS SENIOR ADDITION subdivision have been notified and signed this plat.

I understand and do hereby reserve the easement strips shown on this plat for the purposes stated and for the mutual use and accommodation of all utilities desiring to use or using same. I also understand the following;

- 1. No buildings shall be constructed or placed upon, over, or across the utility easements as described herein.
- 2. Any public utility shall have the right to remove and keep removed all or part of any buildings, fences, trees, shrubs, or other growths or improvements which in any way endanger or interfere with construction, maintenance or efficiency of their respective system on any of these easement strips; and any public utility shall at all times have the right of ingress or egress to, from and upon the said easement strips for purpose

ENGINEER: RKM CONSULTING ENGINEERS, INC. 7616 LBJ Freeway Suite 530 Dallas, Texas 75251 (214) 432-8070
OWNER: WESTERN RIM INVESTORS 2008-2, L.P. 601 Canyon Drive Suite 101 Coppel, Texas 75019

OWNER'S CERTIFICATE

of construction, reconstruction, inspecting, patrolling, maintaining, and either adding to or removing all or part of their respective system without the necessity of, at any time, procuring the permission of anyone.

- 3. The City of Rockwall will not be responsible for any claims of any nature resulting from or occasioned by the establishment of grade of streets in the subdivision.
- 4. The developer and subdivision engineer shall bear total responsibility for storm drain improvements.
- 5. The developer shall be responsible for the necessary facilities to provide drainage patterns and drainage controls such that properties within the drainage area are not adversely affected by storm drainage from the development.
- 6. No house dwelling unit, or other structure shall be constructed on any lot in this addition by the owner or any other person until the developer and/or owner has complied with all requirements of the Subdivision Regulations of the City of Rockwall regarding improvements with respect to the entire block on the street or streets on which property abuts, including the actual installation of streets with the required base and paving, curb and gutter, water and sewer, drainage structures, storm structures, storm sewers, and alleys, all according to the specifications of the City of Rockwall; or

Until an escrow deposit, sufficient to pay for the cost of such improvements, as determined by the city's engineer and/or city administrator, computed on a private commercial rate basis, has been made with the city secretary, accompanied by an agreement signed by the developer and/or owner, authorizing the city to make such improvements at prevailing private commercial rates, or have the same made by a contractor and pay for the same out of the escrow deposit, should the developer and/or owner fail or refuse to install the required improvements within the time stated in such written agreement, but in no case shall the City be obligated to make such improvements itself. Such deposit may be used by the owner and/or developer as progress payments as the work progresses in making such improvements by making certified requisitions to the city secretary, supported by evidence of work done; or

Until the developer and/or owner files a corporate surety bond with the city secretary in a sum equal to the cost of such improvements for the designated area, guaranteeing the installation thereof within the time stated in the bond, which time shall be fixed by the city council of the City of Rockwall.

I further acknowledge that the dedications and/or exaction's made herein are proportional to the impact of the Subdivision upon the public services required in order that the development will comport with the present and future growth needs of the City; We, our successors and assigns hereby waive any claim, damage, or cause of action that we may have as a result of the dedication of exactions made herein.

Matthew Hiles
Authorized Signature
Western Rim Investment 2008-2, L.P.
Signature of Party with Mortgage or Lien Interest

STATE OF TEXAS §
COUNTY OF ROCKWALL §

Before me, the undersigned authority, on this day personally appeared Matthew Hiles, known to me to be the person whose name is subscribed to the foregoing instrument, and acknowledged to me that he executed the same for the purpose and consideration therein stated.

Given upon my hand and seal of office this 2nd day of March, 2009.

Kim D. Whiteley
Notary Public in and for the State of Texas

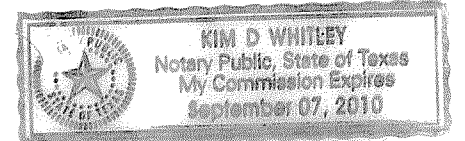

STATE OF TEXAS §
COUNTY OF ROCKWALL §

Before me, the undersigned authority, on this day personally appeared _____, known to me to be the person whose name is subscribed to the foregoing instrument, and acknowledged to me that he executed the same for the purpose and consideration therein stated.

Given upon my hand and seal of office this ___ day of _____, 2009.

Notary Public in and for the State of Texas

**FINAL PLAT
MANSIONS SENIOR ADDITION**

(18.1650 ACRES)

out of

J.M. ALLEN SURVEY, ABSTRACT No. 2
CITY OF ROCKWALL, ROCKWALL COUNTY, TEXAS

PROJECT INFORMATION
Date of Survey: 01/10/2008
Date of Drawing: 03/02/2009
Job Number: 0714829
Drawn By: M.M.D.
File: Final Plat Seniors.Dwg
SHEET 5 OF 6



811 E. Plano Parkway
Suite 117
Plano, Texas 75074
(972) 424-7002 Voice
(972) 633-1702 Fax
WWW.SurveyConsultantsInc.Com

SURVEYOR'S CERTIFICATE

NOW, THEREFORE KNOW ALL MEN BY THESE PRESENTS:

THAT I, Douglas S. Loomis, do hereby certify that I prepared this plat from an actual and accurate survey of the land, and that the corner monuments shown thereon were properly placed under my personal supervision.

Douglas S. Loomis
Registered Professional Land Surveyor No. 5199

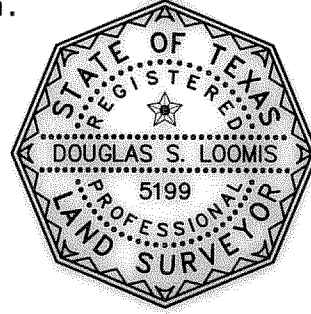

COORDINATE NOTE

Coordinates shown hereon are State Plane Coordinates, Texas North Central Zone, North American Datum of 1983 (NAD83).

FLOODPLAIN NOTE

100-year floodplain, sections and minimum finished floor elevation information provided by RKM Consulting Engineers, Inc.

RECOMMENDED FOR FINAL APPROVAL





Planning and Zoning Commission
Date 01-27-, 2009.

APPROVED

I hereby certify that the above and foregoing plat of an addition to the City of Rockwall, Texas, was approved by the City Council of the City of Rockwall on the 2nd day of FEBRUARY, 2009.

This approval shall be invalid unless the approved plat for such addition is recorded in the office of the County Clerk of Rockwall County, Texas, within one hundred eighty (180) days from said date of final approval.

WITNESS OUR HANDS, this 18th day of march, 2009.

Mayor, City of Rockwall

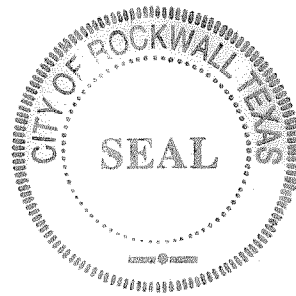
City Secretary

City Engineer 3-17-09



**FINAL PLAT
MANSIONS SENIOR ADDITION**

(18.1650 ACRES)

out of

J.M. ALLEN SURVEY, ABSTRACT No. 2
CITY OF ROCKWALL, ROCKWALL COUNTY, TEXAS

ENGINEER:
RKM CONSULTING
ENGINEERS, INC.
7616 LBJ Freeway
Suite 530
Dallas, Texas 75251
(214) 432-8070

OWNER:
WESTERN RIM INVESTORS
2008-2, L.P.
601 Canyon Drive
Suite 101
Coppell, Texas 75019

PROJECT INFORMATION
Date of Survey: 01/10/2008
Date of Drawing: 03/02/2009
Job Number: 0714829
Drawn By: M.M.D.
File: Final Plat Seniors.Dwg
SHEET 6 OF 6

811 E. Plano Parkway
Suite 117
Plano, Texas 75074
(972) 424-7002 Voice
(972) 633-1702 Fax
WWW.SurveyConsultantsInc.Com

G.394